

SENSIBLE

PRODUCTS INC.

Developed by firefighters...for firefighters.



Start Making Sense

Organize Your Rig the Sensible Way



**Complete Installation
of Equipment at Our Facility!**

*One of fourteen Georgia Emergency Management U.S.A.R. trailers.
Complete equipment mounting and design by Sensible Products.*

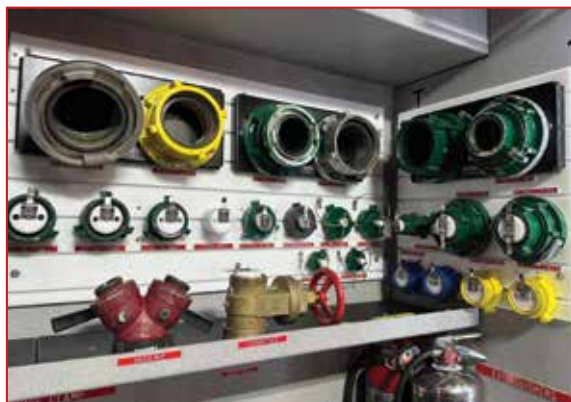

Visit our website www.senpro.net for recent truck outfittings

Quality Products for the Fire Service Since 1985

Dear Valued Customer,

Thank you for your interest in Sensible Products. Our company is owned and operated by retired Fire Chief, Phil McLean, his daughter Brittany, and our team of firefighters. Our many years of fire service experience and engineering background has made Sensible Products a well-rounded organization since 1985.

We are a quality conscious manufacturer of unique holders and bracketry for fittings, adapters, brass goods and tools that may be carried on apparatus. Our products may be sold as individual components and mounted by a fire department, or send us your apparatus. Write us in your apparatus specifications and let us coordinate and complete all the equipment mounting.

We at Sensible Products are sincere in producing quality products and are open to your suggestions or specialized product requests. Please feel free to contact us with any questions or concerns.

Your friends in the fire service,
The Sensible Team



Complete Cabinet Organization

Multiple-Size Fitting Holders	4
Combination Holders	5
Storz Fitting Holders	
for Non-Threaded Fittings	6
Horizontal Mounting Posts	7
Chanl Panl Front	7
Mount Posts	
Gate Valve Mounting Systems	8
Vertical Mounting Posts	8
Quick Locks	8
Handelok Mounting Brackets	9
Jumbo Lok Mounting Brackets	9
Small and Large Clamp Brackets	9
Toolok Mounting Brackets	10
Rip-Tie Kits	10
Adjustamount Systems	10
Nylon Strap Kits	10
Heavy Duty Straps	11
Tool Mounting Clips	11
Tulip Clip	11
Pry Bar Brackets	11
Bolt Cutter Mounting Kits	11
Ring Handle Brackets	12
Heavy-Duty Mounting Brackets	12
D-Handle Mounting Brackets	12
Cord Adapter Brackets	12
Mallet and Wrench Brackets	13
Axe Blade Brackets	13
Axe Head Pockets	13
Universal Tool Pocket	14
Universal Saw Brackets	14
Can Holders	14
Cylinder Brackets	15
D-Size Oxygen Cylinder Brackets	15
Heavy-Duty Extinguisher Brackets	16
New York Hook Bracket	16
Barrier Tape Post	16
Tail Board Mount	17
Span Hammer	17
Multi Rack	17
SenPro Poly Board	18
Engraved Labels	18
New Plastic Storage Boxes	18
Plastic Welded Brackets, Boxes, More	19
Cab Organizer	20
Battery Tool Mount	20
Command Centers	21
EMS Cabinets	21
Chanl Panl Mounting System	22-23
FirstGard Cones/Brackets	24
Pickup Trucks, Command Centers	25
Apparatus Specifications	26-27

Multiple-Size Fitting Holders

One holder adjusts for diameters from 4" to 6".

Simplicity, practicality, flexibility. **Multiple-Size Fitting Holders** from Sensible Products offer these benefits and more at half the cost of conventional, thread-type, large diameter holders.

The unique spring-loaded, capturing-knob design eliminates specialized thread requirements. And because fittings snap on and off, long-handled fittings no longer require extra mounting space for turning. Each holder features selectable positioning of the capturing knobs to accommodate any size fittings in the 4" to 6" diameter range.

Multiple-Size Fitting Holders mount quickly to either vertical or horizontal surfaces, interior or exterior. Two flathead screws are all that is required. The non-corroding, powder-coated aluminum base needs no maintenance, and the capturing knobs are made of a special durable plastic that will not swell or crack. Thirty pounds spring tensioning holds fittings securely while allowing fast on/off action. Stainless steel hardware makes the holder complete.

Order **Multiple-Size Fitting Holders** in either single or double configurations to suit your space requirements.



Part No. TH-1 (Single)
Measures 8" x 8" x 1 7/8"



Part No. (Double) TH-2
Measures 8" x 17" x 1 7/8"

Combination Holders

Combination Fitting Holders - one holder adjusts for diameters from 4" to 6" threaded and 4" to 5" Storz couplings.

Simplicity, practicality, flexibility. The **Combination Holders** from Sensible Products offer these benefits and more at half the cost of conventional large diameter holders. A unique self-locking feature easily mounts 4" or 5" Storz couplings or adapters. Simply drop the adapter in the slots, pull down and its locked in place. To release the fitting just lift up - nothing to turn, spin or unscrew.

For large-diameter threaded fittings, a unique spring-loaded capturing knob design eliminates specialized thread requirements. And because fittings snap on and off, long-handled fittings no longer require extra mounting space for turning. The holder features selectable positioning of the capturing knobs to accommodate any size fittings in the 4" to 6" diameter range.

The durable powder-coated base needs no maintenance and stainless steel hardware makes the **Combination Holder** complete.

**A place for each fitting
and each fitting in its place.**



Storz

Part No. CH-2
Measures 8" x 17" x 1"

Threaded

Storz Fitting Holders for Non-Threaded Fittings

Simplicity and practicality highlight the line of 1/4-Turn Fitting Holders from Sensible Products. The unique self-locking feature easily mounts 3", 4", 5" and 6" Storz couplings and adapters. Simply drop the fitting in the slots, pull down and it's locked in place. To release just lift up – nothing to turn, spin or unscrew. The non-corroding, powder-coated aluminum base needs no maintenance. Two flat-head screws are all that is required for mounting.

Order these holders in either single or double configurations to suit your space requirements.



Part No. SH-1 (Single)
Mounts 4" and 5" Storz
Measures 8" x 8" x 1"



Part No. SH60
Mounts 6" Storz
Measures 10" x 10" x 1"



Part No. SH-2 (Double)
Mounts 4" and 5" Storz
Measures 8" x 17" x 1"



Part No. SH30
Mounts 3" Storz
Measures 6" x 6" x 3/4"

Horizontal Mounting Posts

Want to eliminate the headache of stacking 1.5" to 2.5" couplings, adapters and accessories? Sensible Products offers unique **Horizontal Mounting Posts** for double male or female configurations. These remarkably simple posts are designed to save cabinet storage space and improve overall truck neatness and efficiency. With no stacking, you can instantly spot the size adapter or coupling you need, or tell what's missing. A stainless steel spring clip provides secure holding yet quick-action release. Clips can be replaced as needed at no charge. Durable construction materials will not corrode, swell or crack. Single screw rear mounting takes only minutes.

Custom length posts are available upon request

See Price List for Sizes

Posts also available to accommodate Pac Trac mounting system. Please advise when ordering.



Chanl Panl/ Front Mount Posts

Chanl Panl mounting posts are designed to be used with the **Chanl Panl** mounting board and other front mount applications. Chanl Panl mounting posts are all supplied with the correct mounting hardware to slide into the T-slots. Slide the nuts in place in the T-slot and install the bolts through the front of the post and secure them to the board. You have the ability to move them left to right and position them to best fit your space requirements.

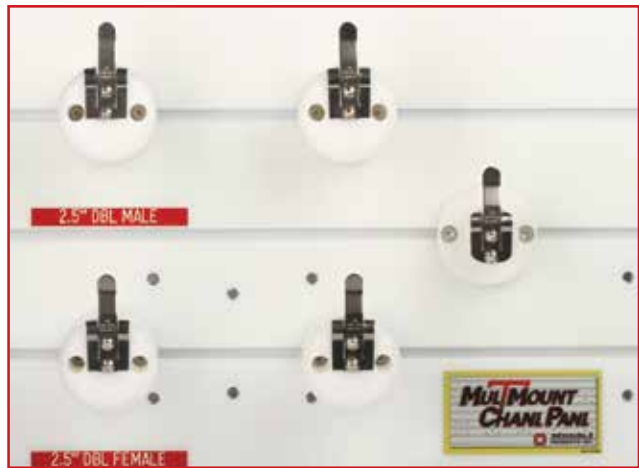

See Price List for Sizes



Gate Valve Mounting Systems

Access to your hydrant gate and wrench is a snap with **Gate Valve Mounting Systems**. This post and bracket can be used to mount ball valves, water thieves or other types of typical-styled products. A powder-coated, 1/4" aluminum bracket and durable mounting post make it suitable for interior or exterior use. A 1" center through-hole is used for hydrant wrench storage.

Order the **Gate Valve Mounting Systems** by specifying the appliance you want to mount. You may also order with or without the through-hole.

Part No. GVM



Vertical Mounting Posts

These **Vertical Mounting Posts** offer easy on-and-off mounting of gated wyes, nozzles, stacking tips and a variety of other equipment. No lever to release, just lift up and go. Exact fitting posts ensure positive mounting and keep equipment ready for use.

Order the **Vertical Mounting Posts** according to the piece of equipment they are mounting. Specify the type and *manufacturer* of the product. Style numbers are listed on the product base.

Example: For the "Gated Wye" post, specify the manufacturer of the "Gated Wye" to be mounted. Custom posts are available upon request.

1.5" Part No. 15VMP
2.5" Part No. 25VMP
Pictures are only one example of vertical posts available.



Quick Locks

Quick Lock - Lever action secures 2.5" & 1.5" appliances.

Part No.
1.5QL
2.5QL



Handelok Mounting Brackets

The **Handelok Mounting Bracket** provides a secure mount for any tool or part that is 1-3/4" diameter or that will fit within the jaw. This unique bracket will self-lock when secured and ensures a secure fit. Quick release in an emergency and high-quality urethanes and stainless steel ensure its durability

Part No. 1004



Jumbo Lok Mounting Brackets

The **Jumbo Lok** features three separate pivot positions to adjust the grip ranges. Grip ranges start at 0.375 and extent to 3.250. This is ideal for heavy duty mounting applications.

Part No. 1070



Small Clamp Brackets

The **Small Clamp Bracket** provides a secure mount for light-duty tools, including shovels and pick handles, or any tool or part that is 1" to 1-1/2" diameter, or that will fit within the jaw. Durable, rubber construction, this unique bracket will self-lock when secured and ensures a secure fit.

Part No. QFB



Large Clamp Brackets

The **Large Clamp Bracket** has a large diameter capacity to accommodate up to a maximum of 2.5" to 9.5", support up to 50 lbs, and securely hold many items in place. Durable rubber construction and three mounting holes located on the flat base. The base measures 6.0" x 7/8" and fastens in place using three #10 screws.

Part No. QFBL



Toolok Mounting Brackets

The **Toolok Mounting Bracket** provides a secure mount for any tool or part that is 1/2" to 1-1/2" diameter. It is injection-molded of the best materials available to provide a long, trouble-free life. Simple to install and use, Toolok is tough, resistant to weather, non-conducting, UV-stabilized and cost effective.

Part No. 1003 - HD

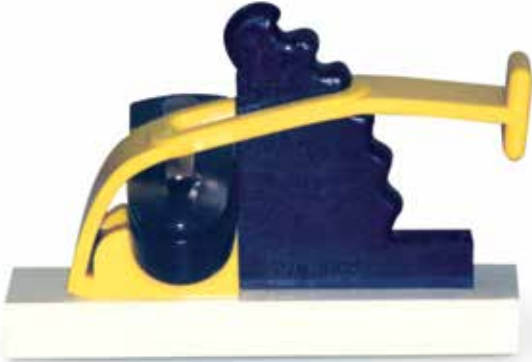

Rip-Tie Kits

Rip-Ties can be used to secure ropes, cords or tools and can be mounted to any surface through two reinforced metal eyelets.

Small style, black:

1" w. x 10" l. - 1 eyelet
2 per pack

Part No. RTKS

Large style, white:

2" w. x 16" l. - 2 eyelets
2 per pack

Part No. RTKL



Adjustamount Systems

The **Adjustamount System** gives you the same positive mount as the Handlelok, but with more flexibility as to the sizes and shapes of the tools or equipment. A 30" adjustable strap lets you set up this mount to meet your exact needs. This unique mount has endless possibilities to conform around many objects to secure them in place. A 12" piece of U-channel secures the strap assembly and mounts to any surface.



Part No. ADJ

Nylon Strap Kits

Nylon Strap Kits include two bolt down footman loop brackets and a 1.00" nylon strap with a pinch and release plastic buckle. Ideal for strapping down tools and/or large equipment such as vent fans, cribbing, rescue jacks and other hard to secure items. Sizes listed are the maximum lengths and may be adjusted to secure smaller items.

30" Strap Kit: Part No. SK30

48" Strap Kit: Part No. SK48

64" Strap Kit: Part No. SK64



Heavy Duty Strap Kit with Metal Buckle

Our new heavy duty line of straps with a metal pinch and release buckle now gives you the option for a wider, heavier duty, easier to see strap for securing all your large equipment needs such as: PPV fans, large equipment bags, or any other hard to secure equipment. New straps are 1.5" wide yellow nylon, with metal buckle, and come with 2 footman loops for mounting. Available in 42", 58", and 72" lengths.

42" length SKY-42
 58" length SKY-58
 72" length SKY-72

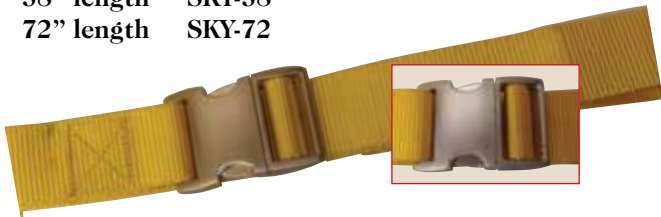

Bolt Cutter Mounting Kits

Post and Pin Bolt Cutter Mounting Kits from Sensible Products offer a simple solution to many mounting problems. As shown below, posts for bolt cutters fit in the "V" behind the cutting jaw and are ordered for the correct diameter to fit this "V". Secured by a stainless pin and lanyard, the post allows the bolt cutter to be mounted in many positions for easy access and storage. One bolt cutter kit contains the proper post size and two tool clips for the handles. Bolt Cutter Kits mount from front or rear.



Part No.	Diameter to fit the proper "V"
BC500	1/2" "V"
BC750	3/4" "V"
BC1000	1.0" "V"
BC1250	1-1/4" "V"

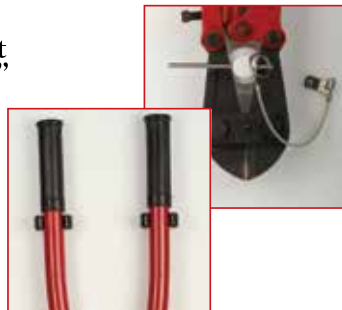

Order Bolt Cutter Mounting Kits according to the proper diameter of the "V".

Tulip Clip

Secure axe handles and other tools. Chrome finish.



Part No. TCC

Pry Bar Brackets

This Pry Bar Bracket is manufactured of raised style die cast zinc with textured chrome finish. Furnished with body gasket, a spring-loaded barrel and a fixed foot end.



Part No. PBB

Tool Mounting Clips

Sensible Products offers a complete line of durable Tool Mounting Clips that can be used to mount hand tools and equipment. These clips are vinyl-coated steel and are available in the following sizes:

Holding Capacities:	Part No.:
3/8" to 5/8"	#500
3/4" to 1-1/8"	#875
1" to 1-1/2"	#1200
1-1/2" to 1-7/8"	#1500



Ring Handle Brackets

Capture the end of the tool or handle with this Ring Handle Bracket

Part No. RCB

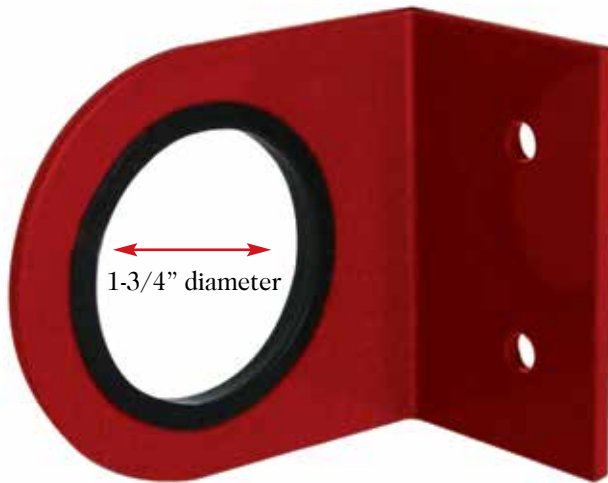

Heavy-Duty Mounting Brackets

Constructed out of 1/8" powder-coated aluminum, these Heavy Duty Mounting Brackets can be used to mount a variety of tools and equipment. The heavy duty construction suits tools such as Haligan, Kelly or Claw tools. The brackets are lined with an aluminum vinyl strip which helps hold tools 1" in diameter securely in place.

Part No. (Set) HDB

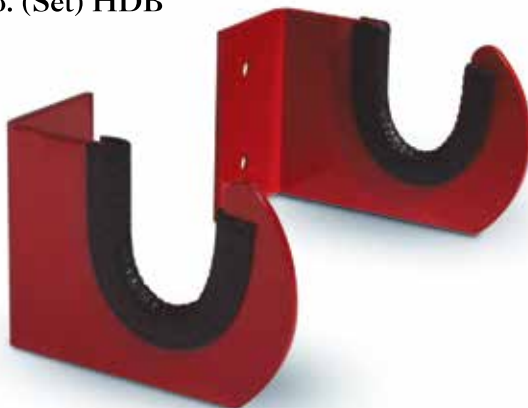

D-Handle Mounting Brackets

D-Handle Mounting Brackets are designed to hang "D"-style handle tools simply and practically.

Part No. DHB



Cord Adapter Brackets

Cord Adapter Brackets help organize loose cords lying around the cabinet area. It allows you to hang up to five cord adapters that are 5/8" diameter in a safe and neat manner. Made of a durable yellow powder-coated aluminum, two mounting screws are all that is needed for proper mounting.

Part No. CRD



Mallet and Wrench Brackets

The depth of the **Mallet and Wrench Brackets** are designed so you may hang a hydrant wrench and mallet together, or whatever type of mallet or hammer that needs to be secured.

Part No. MLT1 (Mallet and Wrench Bracket)

Part No. MLT2 (Mallet Bracket)

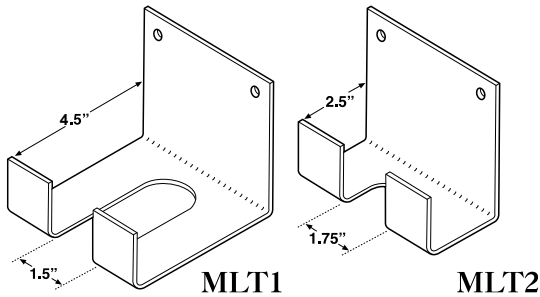

Axe Blade Brackets

Axe Blade Brackets are used to secure axe blades in place safely and efficiently. Made with heavy-duty aluminum, the **Axe Blade Brackets** can be easily mounted with only two mounting screws.

Part No. AXB

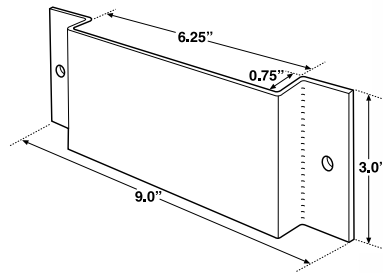

Axe Head Pockets

Constructed out of 1/8" powder-coated aluminum, the **Axe Head Pocket** allows you to store up to two axe heads on any cabinet sidewall or door. They protect axe head edges from damage and the personnel from injury while in storage. **Axe Head Pockets** are intended to be used in cabinets only and not in the apparatus cab. It is also recommended to secure the handles in place.

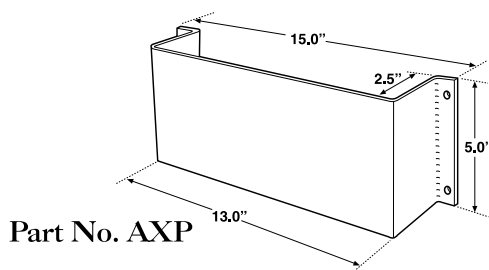

Universal Tool Pocket

This new **Universal Tool Pocket** allows you to store and secure many different items. The inside dimensions of 14.50" long x 4.5" deep allow you to hold four quart bottles of fuel mix or two 110 oz. square cans. Using four mounting holes, you can bolt it to any cabinet side wall to store gloves, bar oil bottles, saw parts, small couplings, and any other small equipment and parts.

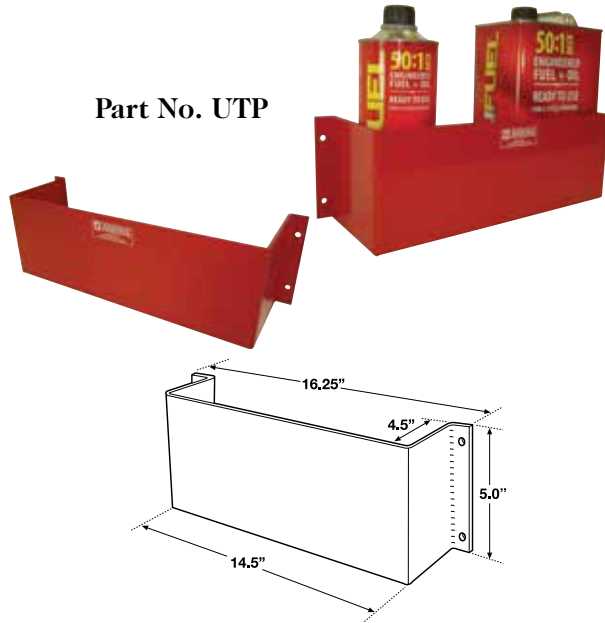

Single/Double Can Holder

The NEW **Single Can Holder** holds a 32 oz. single can of fuel mix. Constructed out of welded, black, HDPE plastic. Four mounting points secure bracket in any position to fit your space requirements. Also available in a double configuration.



Part No. SCH



Part No. DCH

Universal Saw Bracket

This unique **Universal Saw Bracket** is able to mount chain saws, rotary saws, electric and all others. Made from 1/8" powder-coated aluminum, it offers multiple anchor points to attach the heavy duty Velcro strap. An absorbent felt pad is supplied and held in place by the mounting bolts. Universal Saw Brackets come with bracket, pad and strap. The pad is replaceable and may be purchased separately.



Part No. USB
Part No. USBP (Pad Only)

Cylinder Brackets

These **Cylinder Brackets** include back plate, long or short foot plate, two cylinder clips and safety strap. Order by clip size and specify long or short footplate.



D-Size Oxygen Cylinder Brackets

The **Oxygen Cylinder Bracket** has two 4.00" clips to securely hold a D-size oxygen cylinder. Durable green powder-coated steel clips, backplate and footplate. Multiple sets of countersunk holes allow the bracket assembly to flush mount to any surface and gives multiple positioning for the clips and the footplate. A Velcro safety strap is included with each bracket.

Part No. O2D



Heavy-Duty Extinguisher Brackets

These **Heavy-Duty Extinguisher Brackets** are powder-coated steel construction with adjustable rubber straps.

Part No. E862

(for 5 - 10 lb. extinguishers or 4.5" - 7.0" cylinders)

Part No. E864

(for 10 - 20 lb. extinguishers or 6.0" - 8.0" cylinders)



New York Hook Bracket

Sensible Products **NEW New York Hook Bracket** safely and easily mounts your New York Hook. Made of durable, easy to clean, high density polyethylene plastic, these brackets are machined and socketed to fit together and then welded. The hook portion fits securely in this new bracket and we recommend using a **Quick-Fist Bracket (QFB)** or a **Handelok Mounting Bracket (1004)** to secure the handle. Sold separately.

Part No. NYHB



Barrier Tape Post

Want to eliminate searching for Barrier/Scene Tape when it's needed the most? Sensible Products **NEW Barrier Tape Post** safely and easily mounts a roll of this tape. Durable plastic construction materials will not corrode, swell, or crack. Two stainless steel spring clips provide secure holding, yet quick-action release. Two mounting holes through the front of the post provide easy installation.

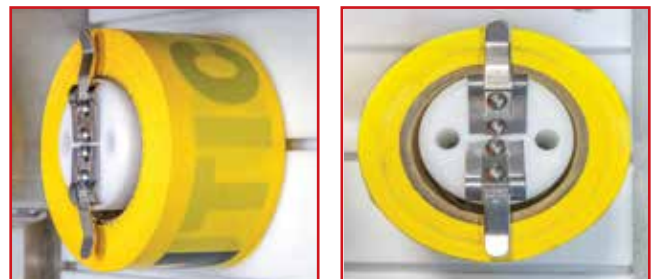

**Part No.
BTP**

Tail Board Mount

The **Tail Board Mount** consists of an 8" x 8" poly plate with a 4" post or 5" post and a strap secured to the plate that can be wrapped and buckled to the fitting.



Part No. TBM-4
(4" Post)

Part No. TBM-5
(5" Post)



(Label not included)

Span-Hammer with Bracket

Simplify your hand tools with the **Span-Hammer**, a unique combination of mallet and spanner wrench. Use this multi-purpose tool to quickly tighten or loosen suction hose connections. Paired with a holder for convenient and secure storage.

- Solid aluminum alloy casting anodized for tough durability
- Replaceable striking cap of high density plastic extends tool life
- Holder is a unique ball handle clamp design for vibration free storage
- Mount vertically or horizontally

Span-Hammer Dimensions: 18" L
Head Diameter: 2.625"
Holder Dimensions: 3.5"W x 10"L x 4.5"H
Part No. Z3132

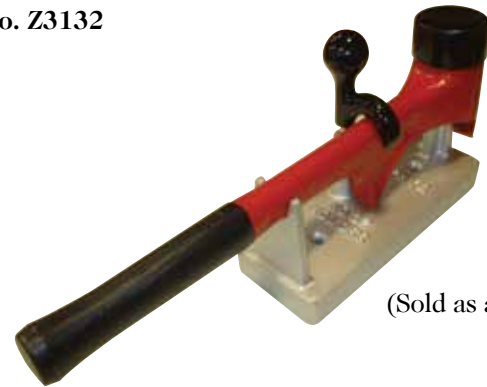

(Sold as a set)

Multi Rack

This unique rack system allows you to nest six tools together in a tight space. The rack design securely holds tools in place in the radiused designed hooks. Additional safety straps hold tension on all the tools.

Made from our durable poly material, the hooks allow tools to slip into place, but are held securely by the radiused design. The two powder-coated aluminum brackets may be positioned to best fit your needs in a cabinet. Two mounting bolts secure each section of the rack. The **Multi-Rack** will allow you to store multiple types, sizes, and styles of tools and maximize your space within a cabinet.

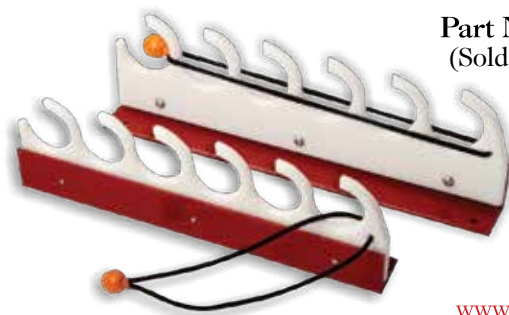

Part No. MTR
(Sold as a pair)



SenPro Poly Boards

(White and Black)

Sensible Products Poly Boards are a durable, easy to clean, high density polyethylene plastic. It is not susceptible to chemical or degradation. The Poly Board is available in custom sizes upon request. It is 1/2" thick which can be drilled and tapped or used with self tapping screws for mounting in your rig.

Standard sizes:

- 24x24
- 24x36
- 24x48
- 30x60
- 4'x8' Sheet

See price list for Part No.

(Parts on board not included)



Engraved Labels

Custom Engraved Labels can be added to tools and equipment to show locations, lengths, sizes and manufacturers as well as all your other labeling needs. Our standard label offered is 1/2" wide by 4" long and with 15 letters. A larger label that is 1" wide by 10" long is also available.

Part No. 110



Part No. 124

Part No.

- #124 - 1/2" x 4" label
- #110 - 1" x 10" label

Colors available -
 Red w/ white
 Green w/white
 Orange w/white
 Blue w/ white
 Black w/ white
 Yellow w/Black

NEW Plastic Welded Storage Boxes

NEW Plastic Welded Storage Boxes are an easy and practical solution to your equipment storage needs. Made of durable, easy to clean, high density polyethylene plastic, these storage boxes are machined and socketed to fit together and then welded. This makes a stronger joint than other current welded boxes. Included are two hand holes on each side for easy carrying. Perfect for storing loose equipment, these storage boxes can be easily moved from compartment to compartment as your space and equipment needs change. Four standard sizes are available. Custom sizes can be made upon request. Quantity discounts may be available.

Sizes

- | | |
|-------------------------------|----------|
| 21" Deep x 10" Wide x 7" High | SB-21107 |
| 21" Deep x 12" Wide x 7" High | SB-21127 |
| 21" Deep x 16" Wide x 7" High | SB-21167 |
| 21" Deep x 21" Wide x 7" High | SB-21217 |

*NOTE: These are external dimensions



Now Offering

Plastic Welded Brackets, Storage Boxes, Dividers and More!

Sensible Products now has the ability to manufacture plastic welded brackets and assemblies at our facility. Our manufactured plastic welded brackets and assemblies provide a strong, durable, and cost effective way to store and mount your equipment. Our products are machined and socketed to fit together and then welded, giving our welded products a stronger joint than other current welded products. We are manufacturing new brackets, storage boxes, and compartment liners/dividers for hose rolls and other equipment. Custom items available upon request.

Single/Double Can Holder



Plastic Welding Assembly Area



Other Applications



Bullet Proof Vest Storage

Cab Storage

Storage Boxes



Map Boxes



Compartment Liners/Dividers



Cab Organizer

- Holds Notebooks & Map Books
- Holds D.O.T. Books
- Glove Box Holder Built In
- Holds Masks and Sanitizer
- Mounts on the Rear Cab Wall
- Can also be used Inside the Firehouse

Part No. CABO



Battery Tool Mount

This NEW tool mounting rack is constructed out of HDPE plastic, and provides slots for four battery tools. A heavy duty retaining straps secured all the tools in place.

Part No. BTM



Command Centers

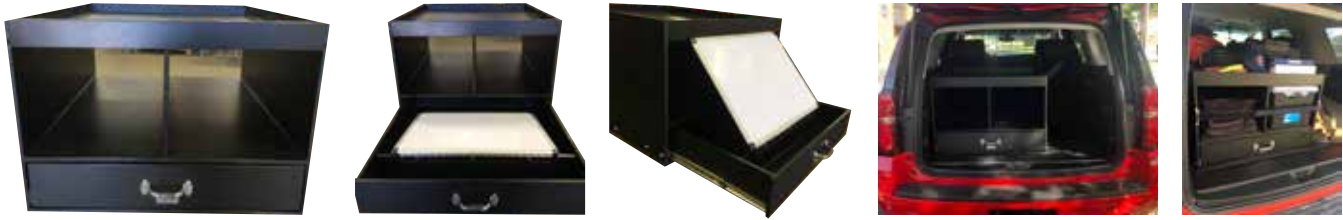

Now offering standard and customizable Command Centers for the back of your Chief or staff vehicles. The Command Centers are an easy and practical solution to your equipment storage needs. Made of durable, easy to clean, high density polyethylene plastic, these Command Centers are machined and socketed to fit together and then welded. This makes a stronger joint than other current designs, but lighter weight than your traditional wood constructed units. Our standard unit consists of two cubby holes for storage and an open area up top with a 2" lip to provide more storage area and to prevent the items from sliding around. Each unit is customizable to your specific needs. Standard unit fits Chevy Tahoe and Ford Explorer. Please call for pricing on custom units or other pictures.

Other Configurations



EMS Cabinets



Now offering standard and customizable EMS Cabinets for the cab of your apparatus. Our EMS Cabinets are an easy and practical solution to your equipment storage needs. Made of durable, easy to clean, high density polyethylene plastic, these EMS Cabinets are machined and socketed to fit together and then welded. This makes a stronger joint than other current designs, but lighter weight than your traditional units. Our standard unit consists of two adjustable shelves, carpeted floors to prevent sliding, and a heavy duty cargo net. Each unit is customizable to your specific needs and priced accordingly. Please call for pricing on these units or for other pictures.



Chanl Panl Mounting System

White or Black



This new universal mounting panel allows the end user to arrange brackets in the cabinet to maximize space. Mount tool or water flow brackets to meet your current needs and easily add brackets to meet your future needs.



FIREFIGHTER FRIENDLY

The **SenPro Chanl Panl** lets you build your water flow cabinet or tool cabinet in a matter of minutes without drilling holes to mount equipment. Slide or position any bracket left to right to maximize space by sliding in the T-Slot.

VERSATILE

The six hole cluster pattern is dimensioned to accept brackets from many different manufacturers. Also use **Chanl Panl** on slide out tool boards in a vertical position.



Add
CHANL PANL
to your next Apparatus Spec.
Ask your Apparatus Builder!

Chanl Panl Mounting System

White or Black



EASY

Easily load all mounting hardware from the front of the SenPro Chanl Panl and secure in place with standard 1/4 - 20 bolts. NO TRICK FASTENERS OR SPECIAL HARDWARE.

DURABLE

This durable, easy to clean, high density polyethylene plastic material is 5/8" thick and may be cut and bolted directly to the cabinet rear or side walls. No need for special end caps or mounting kits. It can also be spaced off the rear cabinet wall to maintain cabinet ventilation

TECHNICAL SPECIFICATIONS

Weight: 92 lbs. per 4' x 8' Sheet

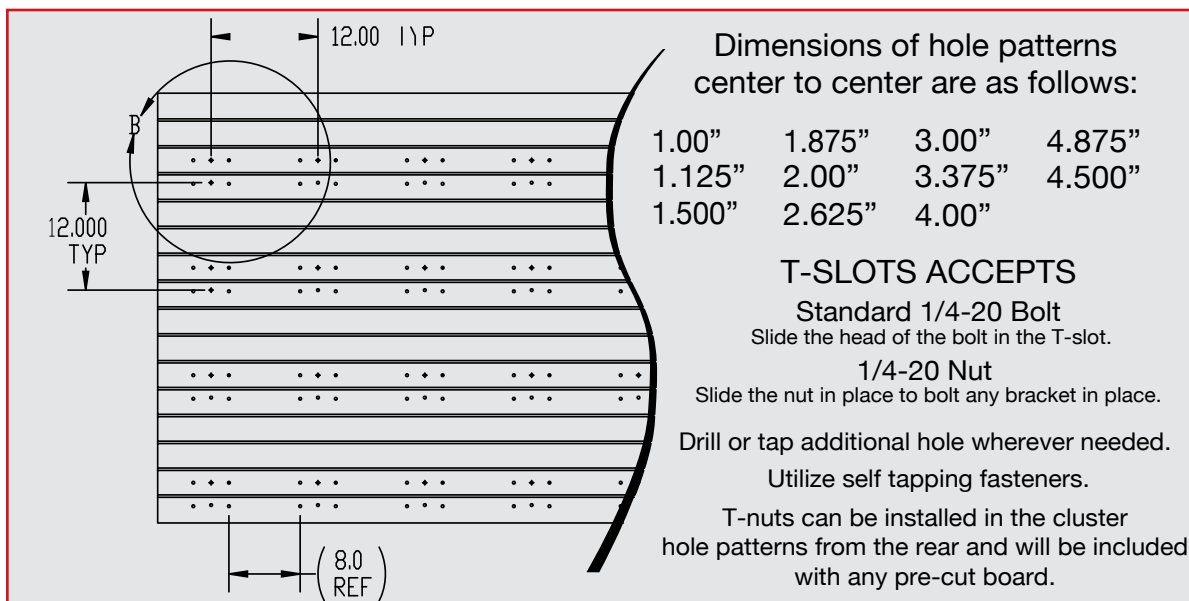

US Patent No. 9,180,591

Chanl Panl has been tested to:

NFPA 1901 2016 Edition 9G Force and 3G Force Requirements 14.1.10.2

Military Spec MIL-STD-810G Method 514.6 Common Carrier

Military Spec MIL-STD-810G Method 516.7 Shock Duration/Shape

Sizes:

24" x 24" Board

24" x 36" Board

24" x 48" Board

30" x 60" Board

4' x 8' Sheet

Or cut to your specific sizes
(Call for pricing)



Chanl Panl is now available in BLACK. Black Chanl Panl is 3/4" thick and does not include the 6 hole cluster pattern.

FIRSTGARD

FOLDABLE CONE

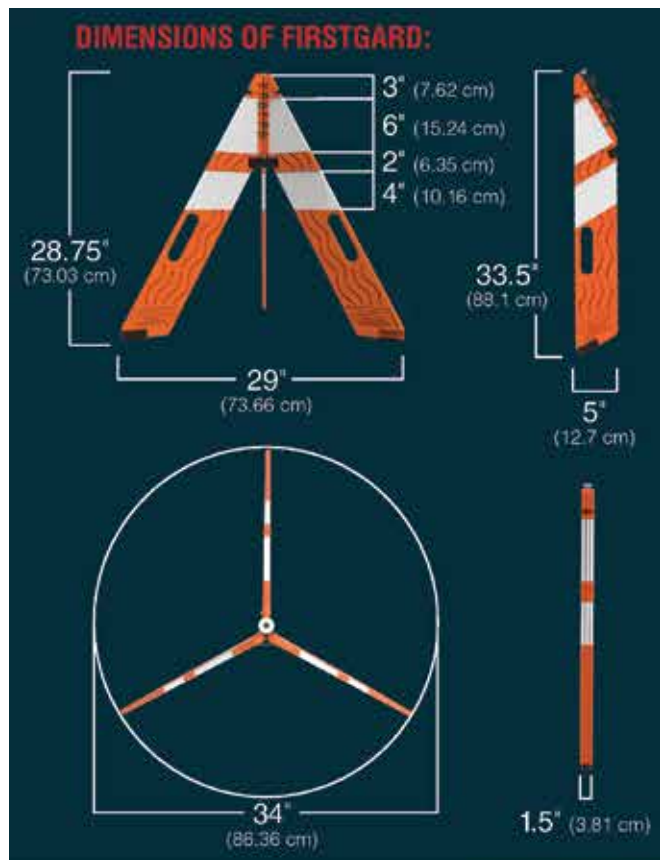

FirstGard Benefits

FirstGard is a patented, foldable traffic cone that can be deployed nearly instantly. Lightweight but heavy enough to remain stable, FirstGard is designed to be transport-friendly, folding to 1.5" wide enabling the storage of multiple units while requiring minimal storage space. This innovation conforms to the MUTCD.

Space Saving Design

Part No. FGC (Set of 5)

Mounting Brackets

Part No. CBH (Horizontal)

Part No. CBV (Vertical)



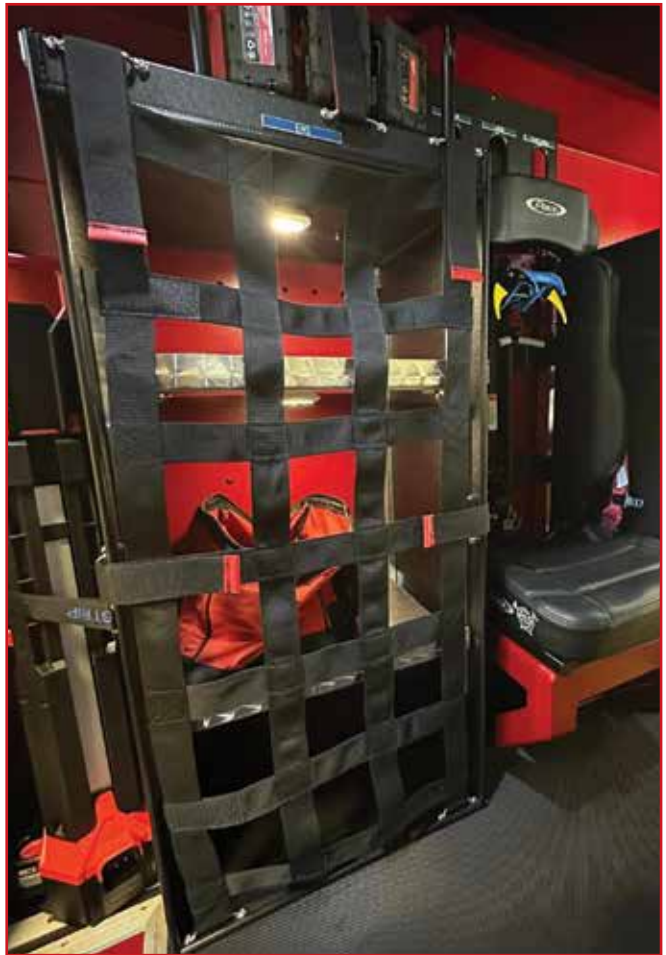
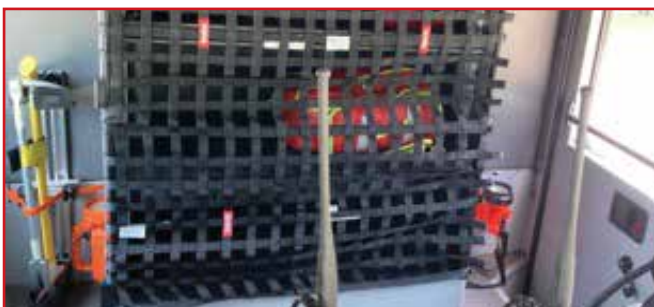

Complete Organization of Your Apparatus & Equipment Mounting at Our Facility We are your “One Stop Equipment Mounting Supplier”

- Order from our catalog and mount equipment at your Fire Department
- Consult with us on building complete water flow or tool boards ready for install
- Contact us for a quote on mounting equipment at our facility or your Fire Department

Once scheduled, average completion time is 7 days.



**Sensible Options for
Your Apparatus:**

*We can do as little or as much
as you would like to new or
existing apparatus*

- Add slide out vertical Chanl Panl boards for tools or water flow equipment
- Slide out floor units or out and down slide units
- Swing out Chanl Panl units above wheel well cabinets
- Extrication and air bags on heavy duty floor slides
- Welded plastic dividers for hose rolls storage and cubby holes

*Work with us on the design &
layout when planning for your
apparatus*



Contact us for organization of large fleets, trailers, utility vans and more.

Sensible Products is a proud supplier of mounting products for the U.S. Military



Equipment Mounting: Use This Technical Description to Put Into Your Apparatus Specifications

The equipment to be carried on the apparatus is all to be mounted per the Fire Department's guidelines and instructions. This is to include, but not limited to, all the fittings and adapters, hand tools, saws, ventilation fans and accessories, shovels, fire extinguishers, salvage equipment, electrical cords and cord adapters, and all other small tools and/or equipment. All equipment is to be labeled with engraved tags. All equipment that is mounted shall be mounted on Sen-Pro Polymer Ready Boards or Chanl Panl.

The Sen-Pro Polymer Boards or Chanl Panl shall also be mounted on all slide out trays, cabinet side and rear walls, and cabinet floors where desired. All the equipment to be mounted is to be delivered along with the apparatus to Sensible Products in Richfield, Ohio. It is the responsibility of the apparatus builder to deliver the apparatus and the equipment to the Richfield facility. Standard pumpers, elevated platforms, ladders, or tower configurations will be completed in seven business days. Contact Sensible Products (330) 659-4212 or info@senpro.net for other apparatus requests.

- Add our standard pricing to your apparatus specification.
- Your apparatus and equipment is delivered to our facility in Ohio, we will mount all equipment and organize your truck, cabinet by cabinet.
- We acquire all mounting hardware, supply any specific bracket or supply the best product to solve the problem.
- Your apparatus will be Ready to Go In-Service when it arrives at your station.
- No additional expense after delivery.
- No additional overtime to mount equipment and put the apparatus in service.
- Professional fabrication and effective utilization of cabinet space will complement your apparatus.



Go In-Service with Sensible!

Specializing for Over 39 Years as a Leading Supplier of High-Quality Mounting Brackets for Fittings, Tools and Adapters

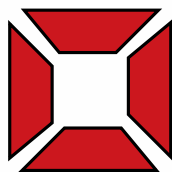

SENSIBLE
PRODUCTS INC.

Sensible Products Inc.

3857 Brecksville Rd., Richfield, OH 44286

Phone: 330-659-4212

Fax: 330-659-2144

info@senpro.net • www.senpro.net

Located 1 mile from the Ohio Turnpike on Brecksville Rd. at I-77 & I-271